

De-Esser User's Guide

Precision DeEsser Users Guide

Metric Halo

\$Revision: 1624 \$

Publication date \$Date: 2011-12-13 16:36:00 -0400 (Tue, 13 Dec 2011) \$

Copyright © 2011 Metric Halo

Table of Contents

1. Introduction	5
Congratulations	5
What is the Precision DeEsser?	5
2. Operating	6
Control Knob	6
Listen control	6
Tooltip control	7
DeEsser detector level meter	7
Gain reduction meter	7
Ess Band Transfer Function	8
Spectragraph Analyzer	8
3. Processing	10
A Detailed Description	10
Ess Band Filter	10
Compressor	10
Threshold Control	11
Ratio Control	11
Attack Control	11
Release Control	11
4. Working with Hosts	12
Pro Tools™	12
Plug-in Window	12
KEY COMMANDS	13
5. Conclusion	14
6. Service and Support	15

List of Figures

1.1. Precision DeEsser's User Interface	5
2.1. Swept Knob	6
2.2. Spread Knob	6
2.3. Listen Control	6
2.4. Tooltip Control	7
2.5. DeEsser detector level meter	7
2.6. Gain Reduction Meter	7
2.7. Ess Band Transfer Function	8
2.8. Spectragraph Display	8
3.1. Signal Flow	10
3.2. Ess Band Filter controls	10
3.3. Compressor controls	11
4.1. Pro Tools Plug-in Window	12
4.2. Compare Button	12
4.3. Automation Window	13

1. Introduction

Congratulations

Thank you for purchasing the Precision DeEsser. You have just transformed your Digital Audio Workstation into a world class vocal processor.

What is the Precision DeEsser?

The Precision DeEsser is a plug-in for digital audio workstations which provides a processor to tame excessive sibilance in vocal tracks.

Features include:

- [Advanced process metering](#)
- [Scalable gain reduction meter](#)
- [Precision filter](#)
- [Flexible dynamics processor](#)
- [SpectraFoo spectragraph analysis](#)

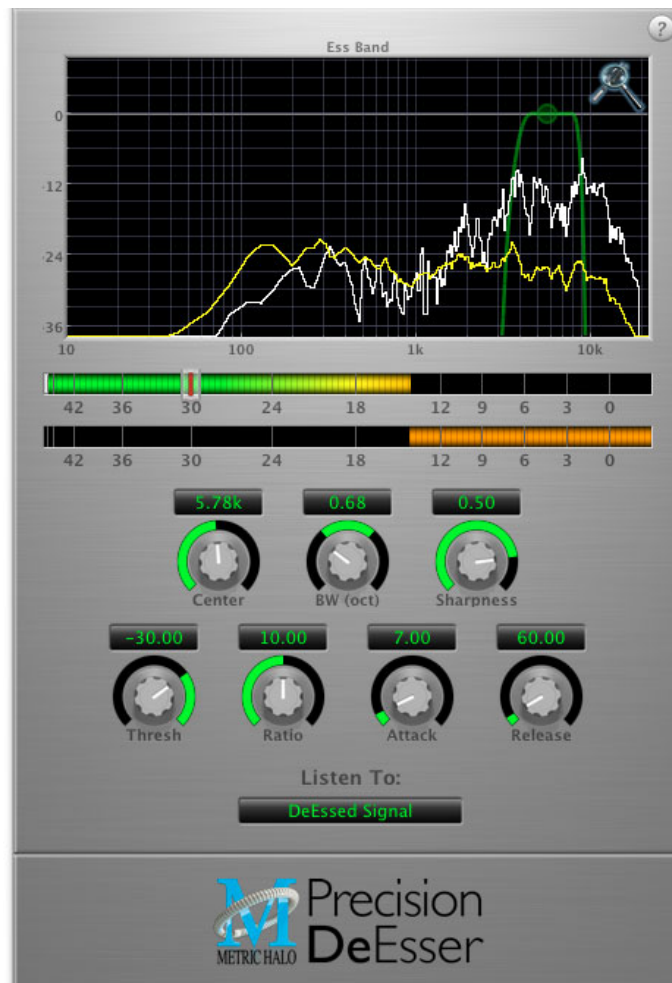

Figure 1.1: Precision DeEsser's User Interface

2. Operating

The Precision DeEsser user interface uses a few different control elements to control all of the processing. These elements are:

Control Knob

Control Knobs are used to control the value of various continuous parameters of a process. Examples of these types of parameters include: Attack time, Release Time, Threshold, etc. There are two styles of encoders:



Figure 2.1: Swept Knob

The rings around these encoders sweep from a minimum to maximum value, from left to right. One exception is the threshold control, which sweeps from right to left.



Figure 2.2: Spread Knob

The ring around this encoder starts at 12 o'clock and spreads to both sides equally as the control is increased. This knob is used for the bandwidth control.

You can change the value of each knob in a number of different ways. Click and drag the knob to change the value continuously. Dragging up or to the right will increase the value, while dragging down or to the left will decrease the value. If you hold down the **⌘** (Command) key when you click, you will be able to adjust the value with finer precision. If you hold the **⌥** (Option) key when you click, the knob will reset to its default value. You may also double-click a knob to reset it.

Click on the number (readout) of the knob to pop up a text entry field that allows you to type in a number directly. The popup will remain active until you dismiss it by clicking somewhere else or hitting the **return**, **enter**, **tab**, or **⌘**. (Command + .) or **ESC** keys. Hit **return** or **enter** to confirm the value and dismiss the popup. Hit the **tab** key to confirm the value and pop up an entry field for the next control. **⇧-tab** (Shift + tab) will pop up the entry field for the previous control). Hit **⌘**. (Command + .) or **ESC** (Escape) to dismiss the popup and cancel the change.

When you enter a number into the pop up entry, you can use a couple of abbreviations: “k” multiplies the number by 1000 and “m” divides the number by 1000. So if you want to enter 16,500 Hz you can just type 16.5k.

Listen control

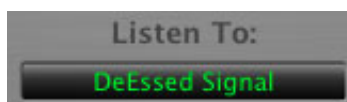

Figure 2.3: Listen Control

This button selects what part of the audio signal you are monitoring:

- *DeEssed Signal*: The final output of the plug-in after processing
- *Esses*: The output of the compressor, without the non-processed audio
- *Detector Signal*: This is the post-filter, pre-compressor audio
- *Out-of-Band Signal*: The Detector signal subtracted from the input; this allows you to hear audio that is *not* being processed
- *Removed Material*: The Esses signal subtracted from the Detector signal; this allows you to hear only the audio that is being removed

Tooltip control



Figure 2.4: Tooltip Control

This button toggles the tooltip display. When enabled, tooltips will be shown when the mouse hovers over a control. When the tooltip display is disabled, you may still see tooltips by holding down the ? key and hovering over a control.

DeEsser detector level meter

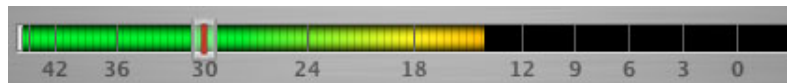

Figure 2.5: DeEsser detector level meter

The Precision DeEsser provides a meter displaying the level of the detector (derived from the from the Ess-band) when the De-Esser is active. The processor threshold is indicated by the red threshold slider above the detector meter. This red bar can be manipulated directly with the mouse. While this meter should never clip (the signal would have to be exceedingly high), the top segment of the meter (above 0dB) is used as a clip indicator and is illuminated red if the input section of the processor detects an over. The clip light remains illuminated until you click on the meter. ⌘ (Option)–click the meter to reset the clip light.

Gain reduction meter



Figure 2.6: Gain Reduction Meter

The gain reduction meter, which has an orange bar and grows down from 0 dB, shows the amount of attenuation being applied by the dynamics processor at any given time. If you right-click or ⌘ (Control) click on the meter, you may set the scale of the gain reduction meter to any of the following values:

- 54 dB
- 24 db
- 12 db
- 6 db
- 3 db

Ess Band Transfer Function

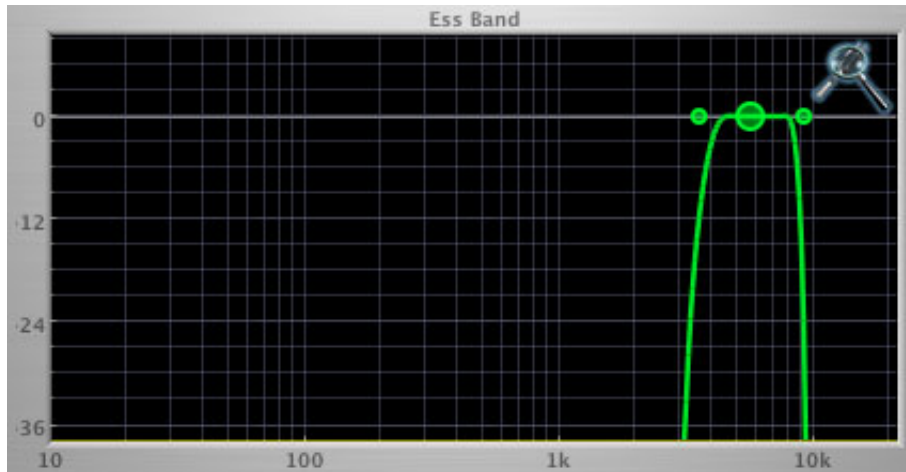

Figure 2.7: Ess Band Transfer Function

The ess band transfer function is a combination of a visual representation of how the de-esser is processing the signal and an intuitive controller for the associated filter. This display is sometimes called a “Cartesian Graph” by other manufacturers.

The horizontal axis provides frequency calibration in Hertz (Hz). The vertical axis provides level calibration in decibels (dBr). The heavy green line indicates the shape of the filter. The center frequency is represented by a large dot in the transfer function with two smaller dots flanking it.

Clicking on the large dot and dragging will allow you to adjust the center frequency. ⌘ (Option)–click and drag the dot to adjust the bandwidth (dragging right increases the bandwidth, left decreases the bandwidth). Click and drag the smaller dots associated with a larger dot to adjust the filter bandwidth.

To dismiss the filter curve, click anywhere in the black area of the transfer function. This will deselect the filter point, and the only trace displayed will be the green master curve.

Spectragraph Analyzer

Clicking the SpectraFoo logo in the upper right hand corner of the transfer function will activate the spectragraph, showing the realtime frequency analysis of your signal:

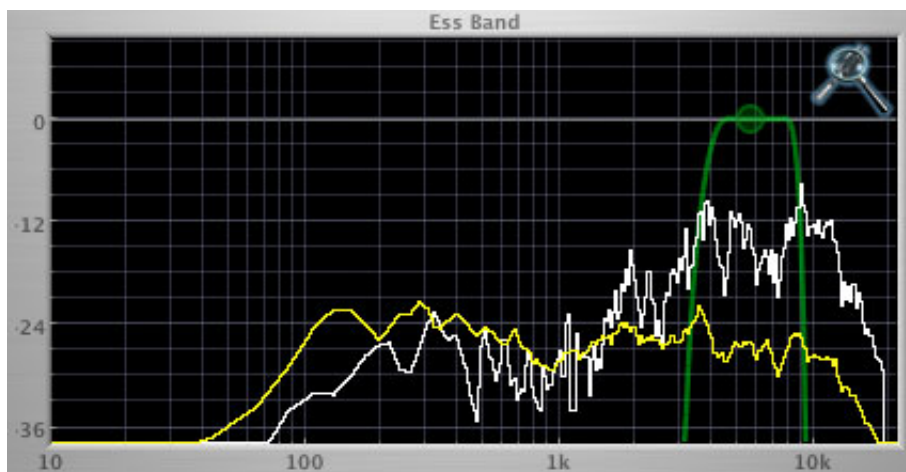

Figure 2.8: Spectragraph Display

The traces are:

- White: Instantaneous display
- Yellow: Average display

The *instantaneous* trace updates in real-time, allowing you to see the immediate peak level of your audio. The *average* trace displays the level as averaged over a short period, giving you a more general view.

The spectrograph analyses the signal currently being audition, as set by the “Listen To:” button. To disable the spectrograph entirely, click the active 'Foo icon.

If you right-click or ^ (Control) click on the transfer function, you will see a menu to set options for the spectrograph:

- Show Instantaneous Trace: Toggles whether the spectrograph shows the instant response of your audio.
- Show Average Trace: Toggles whether the spectrograph shows the averaged response of your audio.

These settings are stored for each instance of the Precision DeEsser.

3. Processing

A Detailed Description

In this chapter we'll discuss how the controls work.

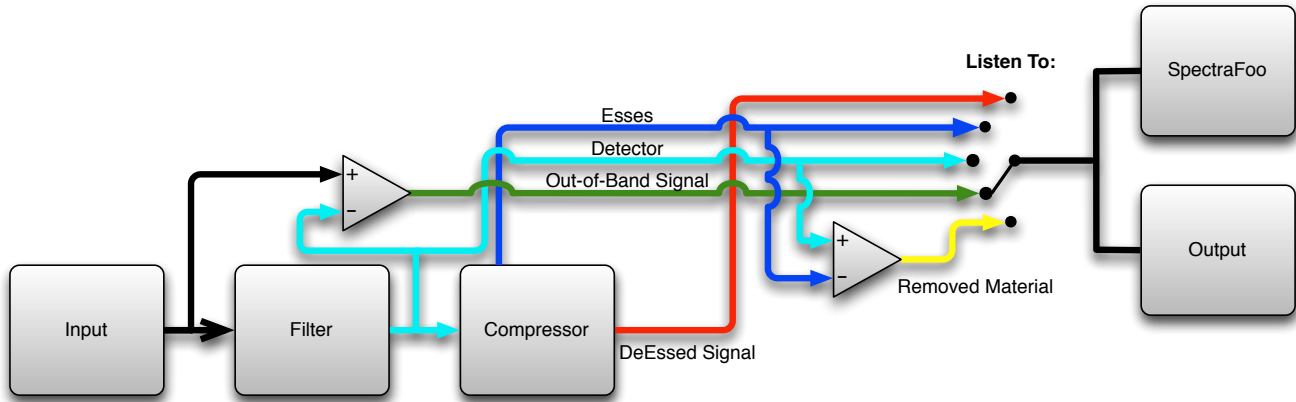

Figure 3.1: Signal Flow

The block diagram above illustrates the overall structure of the processing system provided by the Precision DeEsser. The diagram does not indicate the metering blocks.

Now lets examine the various processing blocks indicated in the diagram.

Ess Band Filter

When the signal is routed to the Precision DeEsser it runs through a filter block that allows you to define the frequency area to be processed.



Figure 3.2: Ess Band Filter controls

The filter controls are:

- *Center*: Sets the center frequency of the ess band filter.
- *BW (Oct)*: Sets the bandwidth of the ess band filter. Higher values widen the filter.
- *Sharpness*: Sets the slope of the filter

To use the filter, set the Center parameter as close as possible to the undesired frequency. Use the BandWidth control to set the overall width of the filter; a narrow bandwidth will let less audio through to the compressor, while large bandwidths will process more overall. By using the Sharpness control you may shape the slope of the filter, to adjust the transition between the processed and non-processed audio.

Compressor

The next processing block is the compressor. The compressor is used to reduce the level of the audio within the filter boundary once it exceeds the threshold.



Figure 3.3: Compressor controls

Threshold Control

The “Thresh” knob controls the level at which the de-esser begins to process audio. When the detector level is below the threshold level no processing takes place. When the detector level is above the threshold level, the gain is reduced at a ratio set by the Ratio control.

The threshold level is also indicated by the red bar above the input meter. You can adjust the threshold level using this indicator as well as by using the “Thresh” knob.

Ratio Control

The “Ratio” knob controls the ratio used to compute the gain reduction of the compressor.

Attack Control

The “Attack” knob allows you to adjust how quickly the gain reduction is decreased to 0 dB when the detector level goes below the threshold level. The maximum value is 100 milliseconds.

Release Control

The “Release” knob controls the release time of the compressor. This parameter is measured in milliseconds and can range from 10 ms to 1000 ms. The release time controls how quickly the compressor closes after the detector drops below the threshold value.

4. Working with Hosts

Pro Tools™

Your Pro Tools software provides a standard interface for controlling various aspects of AAX plug-ins. While you should refer to your Pro Tools documentation for a complete description, we will summarize the most important points here.

Plug-in Window

The illustration below shows the standard Pro Tools plug-in window.



Figure 4.1: Pro Tools Plug-in Window

You can click on the channel name popup in the upper left hand corner of the window (labeled “Audio Recording2.R” above) to switch from channel to channel.

The next popup in the window (labeled “a” above) allows you to switch to another insert on the same channel. You would use this to switch to another plug-in on the same channel.

The bypass button allows you to bypass the effects of the Precision DeEsser. When the bypass is turned on the plug-in will have no effect on the audio track.

The Pro Tools editor/librarian button (the small downward pointing triangle) provides access to a popup menu that allow you to manage presets and libraries of setting for the Precision DeEsser. Use this menu to save libraries or open groups of libraries. See your Pro Tools documentation for more information.

The preset library popup menu (labeled “factory default” above) shows the active preset name (in italics if the current settings do not match the library). Click this popup to select from the available presets.

The “Compare” button indicates when the controls have changed for the current preset settings. Click this button to toggle between your current settings and the preset settings.



Figure 4.2: Compare Button

Clicking the “Automation” button causes Pro Tools to display the plug-in automation configuration dialog box:

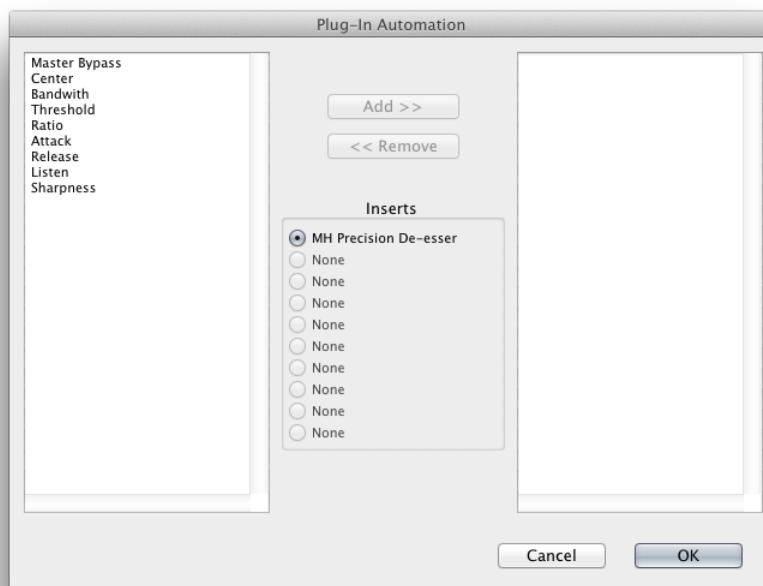

Figure 4.3: Automation Window

This dialog box allows you to enable any or all of the processing parameters for automation. When a parameter is enabled for automation you will be able to record and play-back automated parameter changes directly from your Pro Tools session. If the channel that ChannelStrip is inserted on has automation enabled ChannelStrip will highlight the controls associated with the automated parameters:

- Off: No color
- Read: Green
- Touch, Latch, Write: Red
- Controlled via control surface: Blue

KEY COMMANDS

Pro Tools provides two standard key commands for use with plug-in automation. $\text{^}\text{⌘}\text{⌘}$ (Control + Option + Command)—click a control to pop up a menu that allows you to enable/disable automation of the associated parameter, or to bring up the automation dialog. $\text{^}\text{⌘}$ (Control + Command)—click a control to cause Pro Tools show that control's automation breakpoint graph in the Pro Tools edit window.

5. Conclusion

After working with the Precision DeEsser we hope you will agree that it meets or exceeds the goals that we described in the introduction of this manual. We think that you will find the sonic quality and efficiency of the Precision DeEsser hard to beat.

6. Service and Support

Metric Halo takes great pride in the reputation for customer service and support that we have built. If you have any problems, questions, or suggestions please get in touch with us at:

- <http://mhsecure.com/support>
- support@mhsecure.com
- (727) 725-9555

Please keep us informed about your successes and projects. We love to hear from you!